

MIA FL PAIR DINING CHAIRS

Assembly Instructions - Please keep for future reference

Cat No

QF845

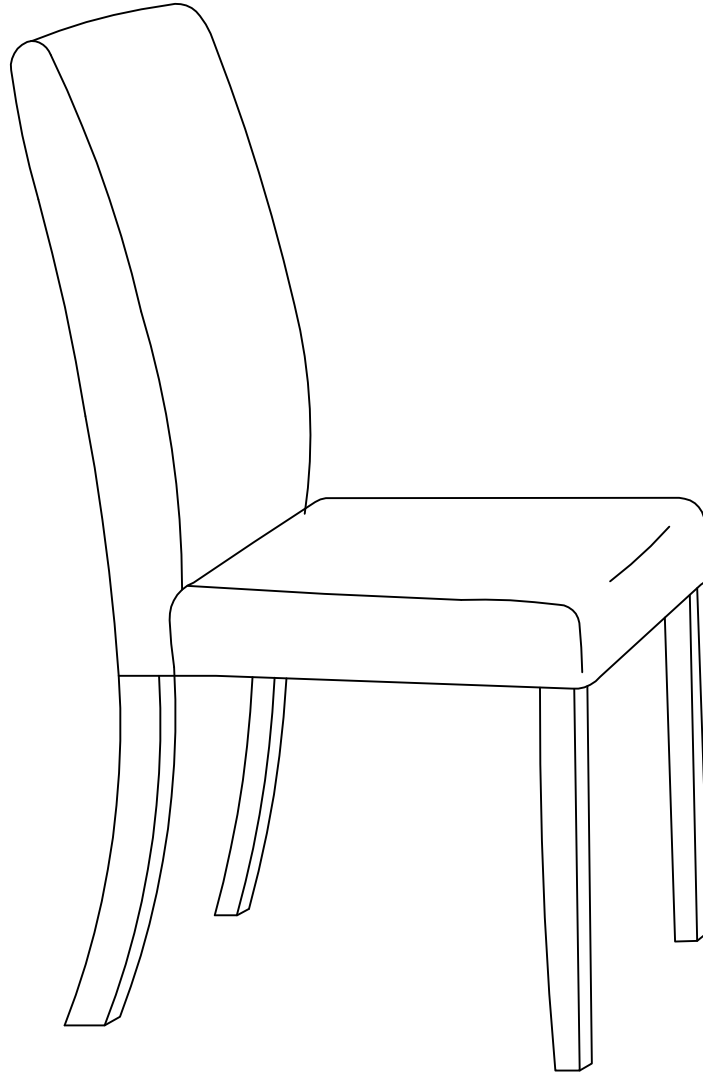

Dimensions	No. people	Assembly Time
Width: 43cm Depth: 50cm Height: 90cm		30 mins (approx.)



Important - Please read these instructions fully before starting assembly

If you need help or have damaged or missing parts, call the **JDW Customer Helpline: 0871 231 2000**

Safety and Care Advice

Important - Please read these instructions fully before starting assembly

- Check you have all the components and tools listed on next pages.
- Remove all fittings from the plastic bags and separate them into their groups.
- Keep children and animals away from the work area, small parts could choke if swallowed.
- Make sure you have enough space to lay out the parts before starting.
- Do not stand or put weight on the product, this could cause damage.
- Assemble the item as close to its final position (in the same room) as possible.
- Assemble on a soft, level surface to avoid damaging the unit or your floor.
- We do not recommend the use of power drill/drivers for inserting screws, as this could damage the unit. Only use hand screwdrivers.
- Dispose of all packaging carefully and responsibly.



Care and Maintenance

- Only clean using a damp cloth and mild detergent, do not use bleach or abrasive cleaners.
- From time to time check that there are no loose screws on this unit.
- This product should not be discarded with household waste. Take to your local authority waste disposal centre.

If you have damaged or missing components, call the JD Williams Customer Helpline on 0871 231 2000

If you are unhappy with the product and wish to return it, please follow the retailer's returns procedure.

Exploded View

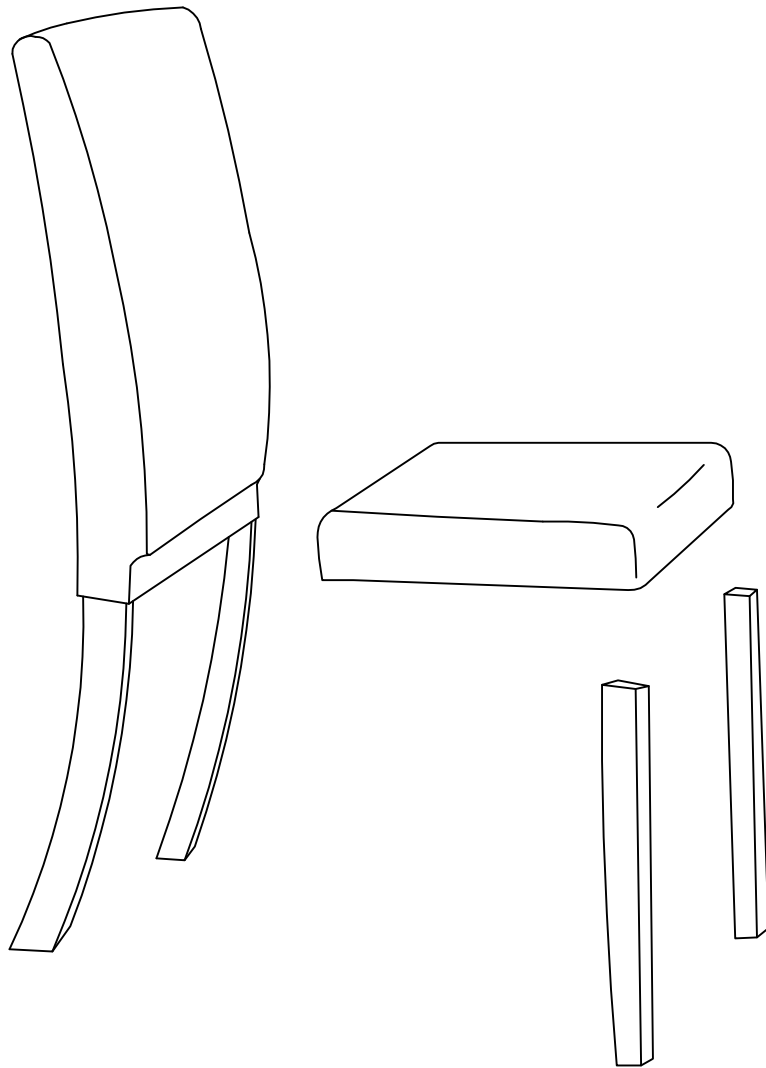

Components - Panels

Please check that you have all the components listed below before constructing your items.





Part No	Description	Qty
1	Back Frame	2
2	Seat	2
3	Leg	4

Components - Fixings

Please check that you have all the components listed below before constructing your items.

Note: The quantities below are the correct amount to complete the assembly. In some cases more fittings may be supplied than are required.

*Hardware packed separately according to the code.

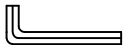
(A)	Screw M6x80mm	(B)	Screw M6x50mm	(C)	Screw M6x40mm	(D)	Flat Washer
							
	8 units		8 units		4 units		20 units
(E)	Spring Washer	(F)	Allen Key M4				
							
	20 units		1 unit				

Tools Required

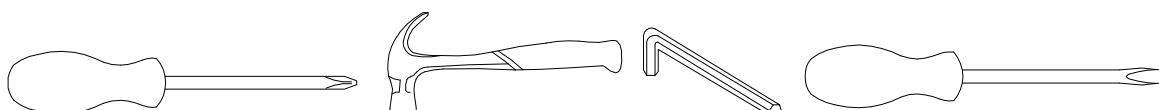

Ruler - Use this to measure your screws (mm)

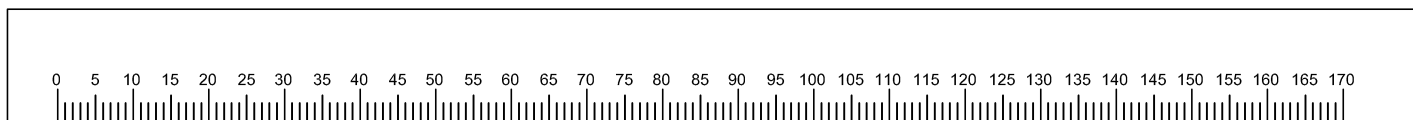

Assembly Instructions

Step 1

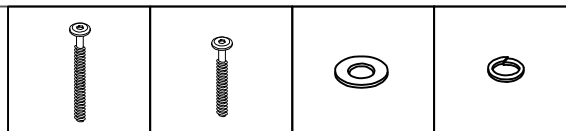
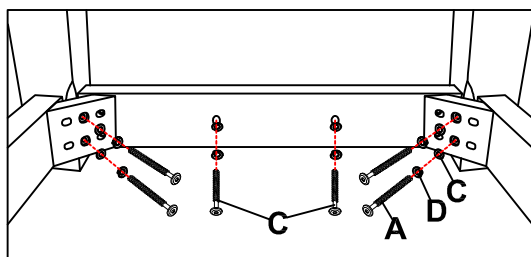

A x 8 **C x 4** **D x 12** **E x 12**

2 x

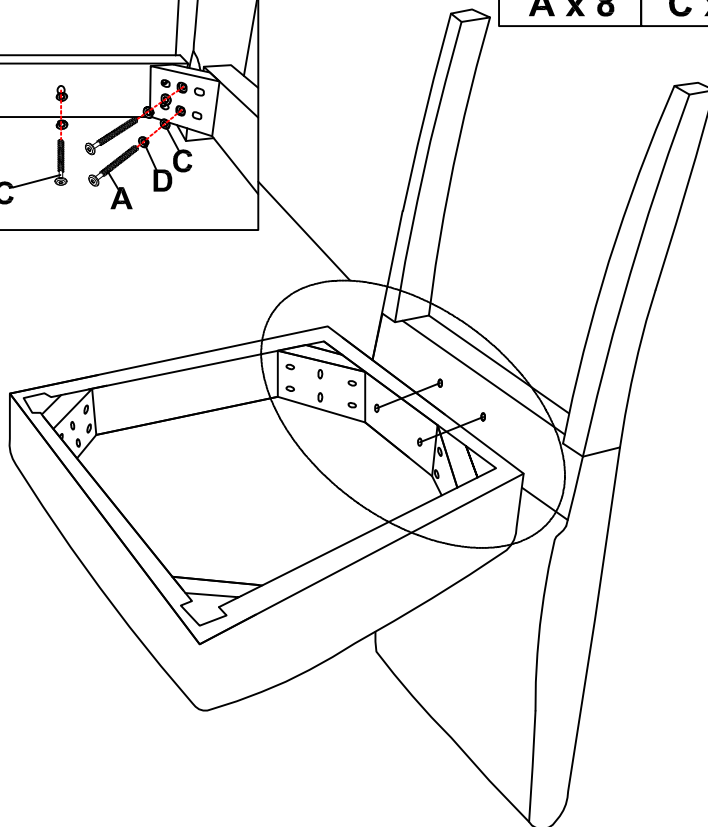

Step 2

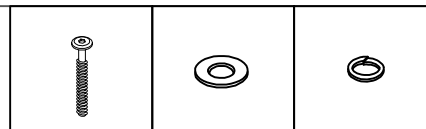
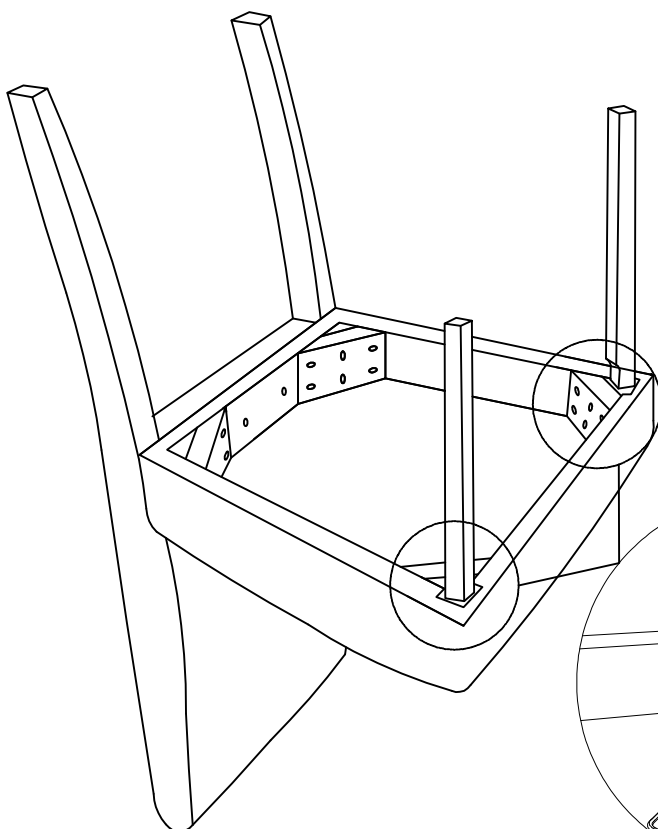

B x 8 **D x 8** **E x 8**

2 x

